

VERSATRIM®

The Leading Molding Brand in North America

No Minimums! • Quick Ship Items! • Largest Color Selection in the World!



Flexible Moldings



Coordinating Moldings



Call Toll Free:
1.866.200.8132

 **Easy Online Ordering**

Versatrim.com

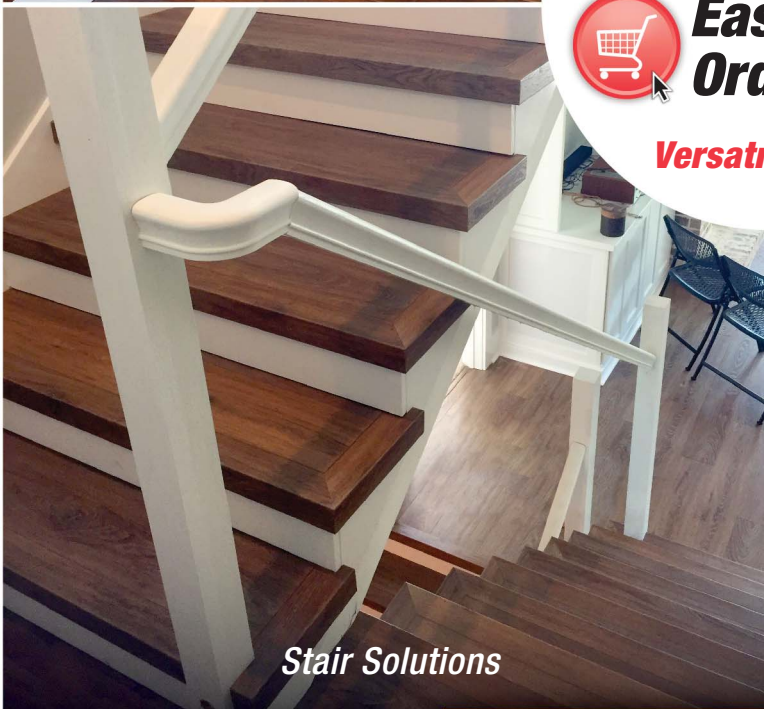

Stair Solutions



Accessories & New Products

THE VERSATRIM GUARANTEE

IF WE DON'T SHIP ON TIME, YOUR NEXT ORDER SHIPS FREE!

Inquire About How Versatrim Can Eliminate Your Inventory and Storage Needs.

**Ask About Our New Award-Winning Products
& New Exact Match Full Stair Treads**

ABOUT US

The Leading Molding Brand in North America!

Versatrim is an award-winning leader in the flooring industry, located outside of Raleigh, NC., that manufactures, sells, and distributes a complete line of custom coordinated floor moldings and trims for laminate and vinyl flooring.

Our innovative approach to molding solutions, and its ability to coordinate with most of the top colors in the vinyl, luxury vinyl tile, wood plastic vinyl, and laminate flooring industry, has guided us to the forefront as a leading manufacturer of floor moldings.

In addition to our core products, we have unique offerings that include flexible moldings, stair solutions, adhesive and a variety of accessories to help complete your flooring projects.

We've proudly been serving our customers for over 25 years. For additional information on our products and services please visit www.versatrim.com.



TABLE OF CONTENTS

About Us.....	1
How to Order / Versatrim Guarantee / Warranty.....	2
Molding Program Options	3
Partnered with Industry Leading Brands	4
Product Highlights.....	5
Standard Moldings / Transitions	7
Shoes & Bases	9
Stair Solutions.....	10
VersaCap Matching Stair Solutions.....	11
White Stair Risers/Versatrim Tread	12
VersaFlex Flexible Moldings.....	13
Accessories/Hardware	15
Introducing Fittes Vents	18
Installation Instructions/Applications.....	19
Marketing Resources.....	21
Sustainability	22
Quantities & Shipping Information.....	23
Pricing.....	25



HOW TO ORDER



How to Order

To Place an Order With Versatrim, please complete the following steps:

- Visit <http://versatrim.com/how-to-order>
- **Complete the 2 forms to establish your credit terms:**
 1. **Credit Application** – We also accept all major credit cards and certified checks in the event that you choose not to have open credit terms with us.
 2. **Company Contact Form** – This form will enable us to correctly identify your company, to expedite your orders and avoid mistakes.

Place Your Order 1 of 4 Ways:

- **Order Online** at versatrim.com and register for a personal account or business account by selecting the option on the top tool bar and follow the steps.
- **Fax in a Completed Order Form** – Go to versatrim.com/how-to-order, download an order form and fax completed form to 252.430.8801 or email it to orders@versatrim.com
- **Fax or Email Your Purchase Order from Your System** – Fax your PO to 252.430.8801 or email your PO to orders@versatrim.com
- **Call Us** – Contact Customer Service by calling **1.866.200.8132**, option 2

Return Policy:

All returns are subject to approval. Call your sales representatives for details.

VERSATRIM GUARANTEE



Guarantee

If we don't ship on time, your next order ships free!

The guarantee is simple: if an order is not shipped on the confirmed ship date, based on our standard lead times, the customer will receive free shipping on their next order of equal or lesser value. This guarantee applies to all orders placed with Versatrim, regardless of size or quantity.

Terms and Conditions:

- Our guarantee will be null and void upon a force majeure due to unforeseen circumstances beyond our control such as a natural disaster (i.e. earthquake, hurricane, flood, other). During such an event, we may be unable to fulfill orders or contractual obligations due to uncontrollable circumstances caused by the natural disaster, especially if hours of operations or suppliers are impacted. We will do our best to inform our customers of any delays in the delivery of our products and services. We remain committed to resolving any issues as quickly as possible.
- On time defined as the estimated ship date on our order confirmation sent to our customers.
- Free shipping & handling credit expires 30 days from the original order shipment date.
- The order that receives free shipping & handling must be equal to or less than the value of the order that shipped late.
- Must use the same shipping method as the original order.
- Standard lead times apply. Anything ordered after noon ET will ship next business day.
- Orders that go on credit hold do not apply.
- Does not apply to LTL shipments or customer pick-ups.
- Holidays & weekends do not count as operational days and can not be included in the lead time commitment.

WARRANTY



Warranty

We Offer a Limited Lifetime Warranty on ALL of Our Moldings

Limited Lifetime Warranty for Laminate Moldings:

Versatrim provides the following conditional limited warranty of its moldings for the lifetime of the original purchaser:

- The laminate surface will not wear through
- The molding will not stain
- The molding will resist damage from moisture due to damp-mopping and small everyday spills when removed promptly



If we don't ship on time, your next order ships free! Guaranteed.



Get Started!



MOLDING PROGRAM OPTIONS

We have a molding program to fit your needs! Talk to your Sales Representative for more Information!

Stocking Inventory Program

Low inventory stock program provides flooring companies the ability to save money on volume purchases and to stock their best selling skus. Low minimum purchase of 30 pc color/profile. We have partnered with many flooring companies and popular brands over the years and are a valuable resource for them. To learn more about our Coordinating Molding Program and explore the wide range of options available, scan the QR code provided at the top of the page.

Quick Ship Program

Includes 7 trim profiles all ready to ship next business day with no minimums This program offers our lowest price point, and we provide on-line installation instruction, saving you both time and money. Our goal is to make sure you get a high-quality product at a reasonable price in a quick production time. Scan the QR code at the top of the page for additional detail and color options available.

Coordinating Molding Program (CMP)

If you don't see a color in our Standard Stock colors or on our website that match your floor, don't stress we have your solution! We have partnered with many flooring companies and popular brands over the years and are a valuable resource for them. Just send us the floor and we will create a custom color to coordinate with your moldings.

To learn more about our Coordinating Molding Program and explore the wide range of options available, talk to your Sales Representative or fill out a quick form by scanning the QR code at the top of the page to get started today!

Versatrim offers a limited number of free marketing materials and samples for all retailers, distributors, and manufacturers.

Go to <http://versatrim.com/free-samples> more information on these options.

For all program options, please send your floors to our print department at the below address:

**Versatrim, LLC
Attn: Print Department
101 Eastern Minerals Road
Henderson, NC 27537
USA**

Please contact your Versatrim Sales Representative for more details on any programs to accommodate all of your molding needs.

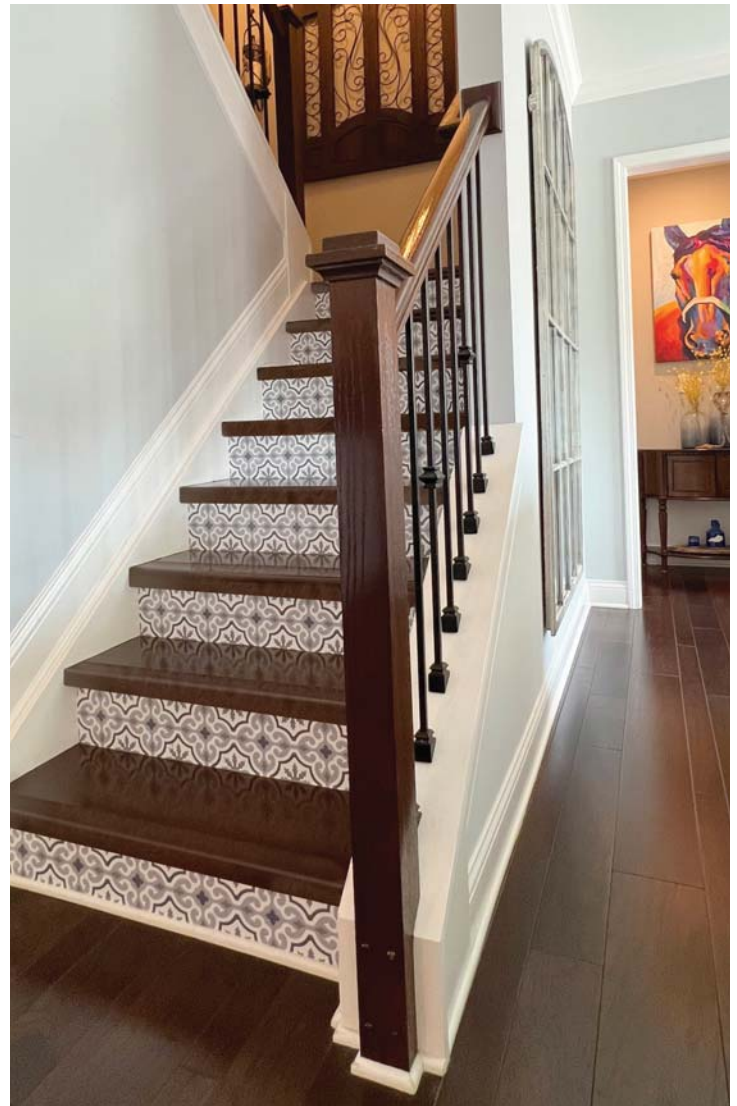

Order online at versatrim.com or call 1.866.200.8132

Send Us Your Floor and We Will Create A Coordinating Trim. No Minimums! No Inventory!

COORDINATING MOLDINGS FOR THESE FLOORS & MORE:

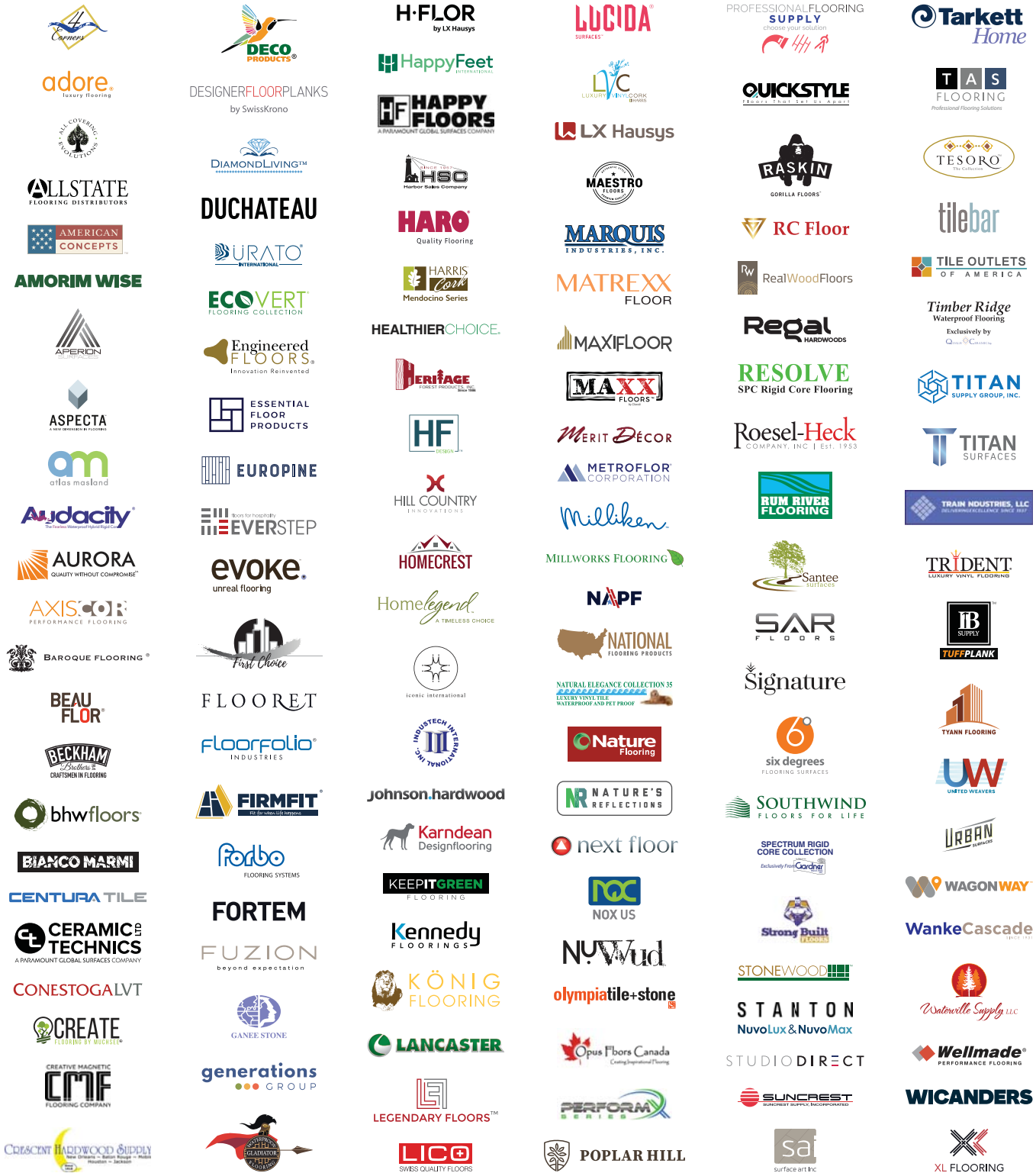

HOW TO ORDER
PROGRAM OPTIONS/ PARTNERSHIPS
PRODUCTS
APPLICATIONS
MARKETING ASSISTANCE/ SUSTAINABILITY
SHIPPING INFORMATION/ LEAD TIMES
PRICING

We create coordinating moldings for YOUR floor! Call us for more details.



Product Highlights



PRODUCT HIGHLIGHTS

Versatrim is the Leader in Trim Innovation Offering "Everything But the Floor!"

We've expanded our product portfolio to provide our customers with the following NEW innovative products: Our full tread stair solution, the Versatrim Tread, 10-Inch Saw Blades, white stair risers with VersaCap bundle options, the only Molding Adhesive you'll need for all your flooring projects! Available now, we are introduced the NEW VersaCap Round profile to our popular matching stair solutions.

NEW!
Available Now!

VERSATRIM TREAD

Versatrim offers a custom full tread stair solution made from your exact floor planks.

PRODUCT HIGHLIGHTS:

- Combines our VersaCap with your flooring plank
- Quick, easy installation with our **Molding Adhesive** (See box in bottom right corner of flyer).
- Available as a pack with our TFL **White Stair Risers** (See below).
- Available in **VersaCap Round, Square, and Edge**

The tape shown is removed on install and leaves no adhesive residue after installation.

Installation with Versatrim Molding Adhesive is required for warranty coverage.

See page 12 for more information.

NEW!
In Stock

10" SAW BLADES

Our high quality 10" Saw Blade is ideal for floor moldings and is designed for ultra smooth cross cutting on a table saw or miter saw.

PRODUCT HIGHLIGHTS:

- High quality carbide tipped teeth for smoother cuts & longer life
- 80 Teeth Alternate Bevel (ATB) tooth geometry specifically for fine crosscuts
- Wide range of applications, wood plywood, MDF, HDF & even some non-ferrous metals like aluminum
- Specifically tested and endorsed for all our trim products, including VersaCap & aluminum VEX
- Blade can be sharpened as needed for long life & superior performance
- Heat Resistant Non-Stick coating reduces gumming for easy cleanup & cleaner cuts

Ships FREE with Any Molding Order.*

See page 26 for pricing.

Available Now!

VersaCap Round

PATENT PENDING

See page 11.

WHITE STAIR RISERS

Used to enhance stair landings.

Surface Material: High Quality TFL (Thermally Fused Laminate)

Material: Standard Particle Board

This product is excluded from our free shipping options.

PRODUCT HIGHLIGHTS:

- Ready to install with a durable TFL white finish
- Lightweight and non-warp particle board core
- Paintable surface**
- Available as a kit option for our VersaCap
- Available in **2 lengths: 46" & 96"** and **2 thicknesses: 3/8" & 5/8"**
- VersaCap Bundle Options available

See page 12 for more information.

MOLDING ADHESIVE

The ONLY Molding Adhesive You'll Need!

This wet-set, early-grab, 12-hour curing formula is low-odor and easy-to-clean, leaving no surface residue or ghosting, even once dried. It provides an excellent bond for moldings.

PRODUCT HIGHLIGHTS:

- No Shrink Formula
- High Strength, Waterproof
- Extremely Low VOC
- Covers roughly 15-20 Lin. Ft. depending on application and bead size
- No Surface Residue
- 12-Hour Cure Time

10 oz. Cartridge

1 Adhesive Tube Ships FREE with Any Molding Order.***

Adhesive is also available in a case of 12 tubes.

See page 26 for pricing.

*\$8.50 Flat rate shipping for blade only orders. For lower 48 Continental United States only. Please inquire with your Sales Rep for Alaska, Hawaii, or any other freight quotes.

**Requires a light sanding before painting

***\$8.50 Flat rate shipping for adhesive only orders. For lower 48 Continental United States only. Please inquire with your Sale Rep for Alaska, Hawaii, or any other freight quotes. Boxes & Cases ship FOB Henderson.

THE VERSATRIM GUARANTEE
IF WE DON'T SHIP ON TIME, YOUR NEXT ORDER SHIPS FREE!

New Products to help with Floor Installation. We Offer Everything But the Floor!

Installing a new floor? Our new CalFlor Flooring Installation Kit includes: 3 useful tools: 1 Heavy Duty Steel Pull Bar, 20 Stepped Installation Spacers, and 1 VersaBlock Tapping Block, which is also available separately. Use BlueZone Perimeter Sealant Tape to protect your floor & subfloor from spills. We've also added the following new products: Fittes floor vents, primed-white quarter rounds & base shoes, and a new VersaFlex Corner Molding profile, all designed to help beautify your floor!.

NEW!
In Stock

CALFLOR FLOORING INSTALLATION KIT WITH VERSABLOCK



Features quality products, designed to make your projects go smoothly. The kit features the **VersaBlock**, an easy-to-use tapping block!

VersaBlock Also Available Separately

PRODUCT HIGHLIGHTS:

- Sturdy tapered steel pull bar to withstand many installs
- Stepped installation spacers are suitable for different expansion specs
- VersaBlock (Also available separately), features 3 different edges to work with multiple styles of flooring

1 Kit or 1 Block Ships FREE with Any Molding Order.*
 Kit is also available in a box or of 10 kits and the VersaBlock is also available in a box of 24 or a case of 72 blocks.
 See page 26 for pricing.

NEW!
In Stock

BLUEZONE PERIMETER SEALANT TAPE



As an alternative to traditional caulking methods, BlueZone applied around the perimeter of flooring installations will effectively seal the expansion area, preventing spills from damaging both the flooring and subfloor with proven moisture-proofing technology against liquids.

PRODUCT HIGHLIGHTS:

- Easy, clean application
- No special tools needed
- Low-temperature adherence
- Tear resistance
- Prevents moisture intrusion into floor expansion areas
- Low cost
- Bonds well to most surfaces

1 Roll Ships FREE with Any Molding Order.*
 Also available in a box of 12 or a case of 144 rolls.
 See page 26 for pricing.

Available Now!

VersaFlex Corner Molding



See page 14.

NEW!
In Stock

INTRODUCING Fittes VENTS



Introducing 8 new in-stock Fittes Vents! These stylish and functional vents are the perfect complement to your flooring projects, adding a touch of modern elegance to any space.

PRODUCT HIGHLIGHTS:

- Sleek and contemporary design that seamlessly blends with modern interiors
- Durable construction for long-lasting performance and reliability
- Easy installation for convenience & efficiency in your projects

Ships FREE with Any Molding Order*

*\$15 Flat rate shipping for vents only orders. For lower 48 Continental United States only. Please inquire with your Sales Rep for Alaska, Hawaii, or any other freight quotes.

See page 26 for pricing.

PRIMED WHITE QUARTER ROUNDS & BASE SHOES

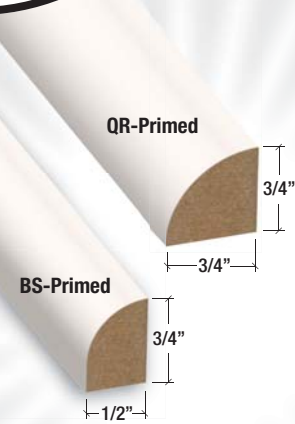

Quarter Rounds & Base Shoes are used to conceal the space between the wall's baseboard and the flooring.

Surface Material: Primed Painted Surface
Core Material: Standard MDF
Length: 96" Long
Quantities: Factory direct skid quantities. Please inquire with your sales associate for details

This product is excluded from our free shipping options.

PRODUCT HIGHLIGHTS:

- 96" Length available in full skids/pallets only
- 3/4" Height
- Primed and ready to paint

See page 26 for pricing.

*\$8.50 Flat rate shipping for adhesive, tape, VersaBlock, or kit only orders. For lower 48 Continental United States only. Please inquire with your Sales Rep for Alaska, Hawaii, or any other freight quotes.

HOW TO ORDER	PROGRAM OPTIONS/ PARTNERSHIPS	PRODUCTS	APPLICATIONS	MARKETING ASSISTANCE/ SUSTAINABILITY	SHIPPING INFORMATION/ LEAD TIMES	PRICING
--------------	----------------------------------	----------	--------------	---	-------------------------------------	---------



Product Details



TRANSITIONS:



Reducer – Available in both Standard and Moisture-Proof options!

Reducers are used to transition between floors of different heights with a minimum height difference of 1/4" (6.35 mm).

Surface Material: High Wear Resistant Aluminum Oxide Laminate

Core Material: Our standard reducer molding is made of moisture-resistant MDF, while our Moisture-Proof variety is an exterior grade composite wood product.

Length: 94" Long

Floor Thickness*	Accessories Needed	Hardware Included
9/32"-15/32" (7-12 mm)	Versatrack- <i>Sold Separately</i>	None
15/32"-5/8" (12-16 mm)	Versatrack & Shim- <i>Sold Separately</i>	None

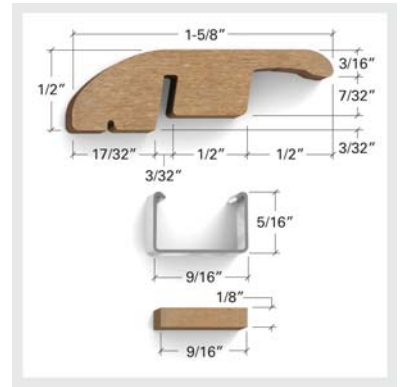

T-Molding – Available in both Standard and Moisture-Proof options!

T-Moldings are commonly used in doorways to join two floors in adjoining rooms. Also recommended when making a transition from one floor to another that is approximately the same height.

Surface Material: High Wear Resistant Aluminum Oxide Laminate

Core Material: Our standard floor transition molding is made of moisture-resistant MDF, while our Moisture-Proof variety is an exterior grade composite wood product.

Length: 94" Long

Floor Thickness*	Accessories Needed	Hardware Included
5/16" (8 mm)	No Track or Shims (Glue Down)	None
23/64"-15/32" (9-12 mm)	Versatrack- <i>Sold Separately</i>	None
15/32"-19/32" (12-16 mm)	Versatrack & Shim- <i>Sold Separately</i>	None
19/32"-45/64" (15-18 mm)	Versatrack & 2 Shims- <i>Sold Separately</i>	None

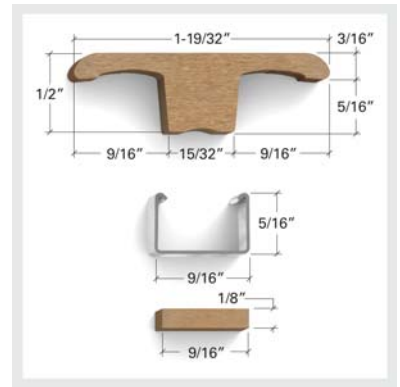

End Cap – Available in both Standard and Moisture-Proof options!

End Caps are used to transition from flooring to carpet, masonry (fireplaces), sliding doors and other exterior door jams.

Surface Material: High-Wear Resistant Aluminum Oxide Laminate

Core Material: Our standard flooring end cap is made of moisture-resistant MDF, while our Moisture-Proof variety is an exterior grade composite wood product.

Length: 94" Long

Floor Thickness*	Accessories Needed	Hardware Included
9/32"-15/32" (7-12 mm)	Versatrack- <i>Sold Separately</i>	None
15/32"-5/8" (12-16 mm)	Versatrack & Shim- <i>Sold Separately</i>	None

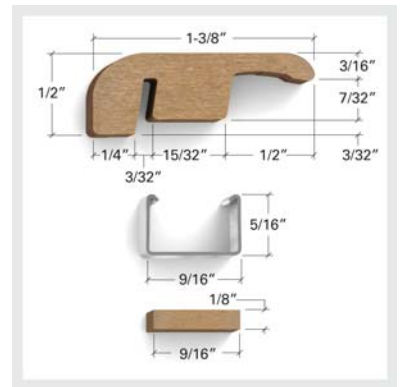

OUR MOLDINGS ARE AVAILABLE AS WATERPROOF!

Information About Our Moisture Proof Material

- The core material is not considered 100% water proof. However, it is moisture, rot, and termite resistant.
- It is treated with zinc borate and manufactured with phenolic resins.
- It has no added urea formaldehyde.
- It is made using sustainable materials and contributes to industry green building programs.
- Caliper swell when saturated in water improves 1-1/2 to 5 times comparing our moisture proof core material to moisture resistant grade and typical MDF.
- In comparison to MDF in internal bucket testing, our moisture proof material exhibited substantially smaller edge cracks after exposure and air drying than typical MDF.



*All references to flooring thickness refer to the total thickness of all components of the floor installation being laid upon the subfloor. This typically is comprised of the flooring plank, e.g. Vinyl or Laminate, the underlayment, either attached or loose lay and any additional vapor barriers.



SlimTrim (3-in-1 Floor Molding)

Our SlimTrim 3-in-1 Molding functions as a Reducer, T-Molding, and End Cap. It comes with SlimTrack & Versatrack Shim for floors up to 1/4" (6.35 mm) or dowels for floors up to 3/4" (19 mm).

Surface Material: High-Wear Resistant Aluminum Oxide Laminate

Core Material: PVC

Length: 94" Long

Floor Thickness*	Packaging Option Needed	Hardware Included
Under 1/8" (3 mm)	SLT-P33	No Hardware Included
Up to 1/4" (6.35 mm)	SLT-P29	Track & Shim
As a T-Molding: 1/4"-3/8" (6.35-9.5 mm)	SLT-P54	Track & 2 Shims
Up to 3/4" (19 mm)	SLT-P32	1 Tree of 8 Dowels
Up to 3/4" (19 mm)	SLT-P31	Track, Shim, & Dowels

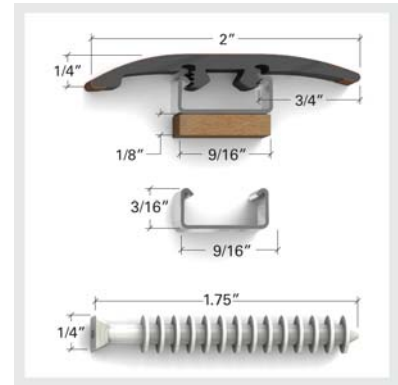

SlimCap (PVC End Cap)

Low profile End Cap for floors up to 1/2" (12.7 mm).

Surface Material: High-Wear Resistant Aluminum Oxide Laminate

Core Material: PVC

Length: 94" Long

Floor Thickness*	Packaging Option Needed	Hardware Included
Up to 3/8" (9.5 mm)	SCAP-P29	Track & Shim
3/8"-1/2" (9.5-12.7 mm)	SCAP-P54	Track & 2 Shims

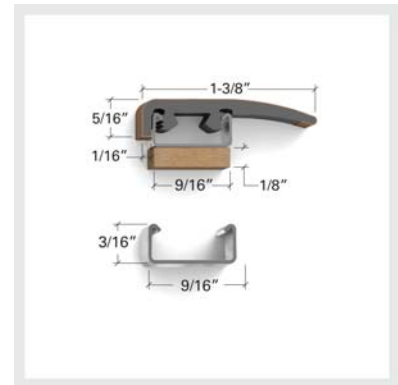

SlimTrim and SlimCap are available with an AC-5 rating. Please inquire with your Sales Representative for more details.



Focus on Selling Floors, Not Managing Moldings!

THE VERSATRIM SOLUTION:

No Minimums • Fast Lead Times • Any Color

Efficiency Matters!

Everything But The Floor!

*All references to flooring thickness refer to the total thickness of all components of the floor installation being laid upon the subfloor. This typically is comprised of the flooring plank, e.g. Vinyl or Laminate, the underlayment, either attached or loose lay and any additional vapor barriers.



Product Details



SHOES & BASES



Quarter Round – Available in both Standard and Moisture-Proof options!

Quarter Rounds are used to conceal the required expansion space between the wall and the flooring.

Surface Material: Decorative Paper

Core Material: Our Standard quarter round is made of moisture-resistant MDF, while our Moisture-Proof variety is an exterior grade composite wood product.

Length: 94" Long



Base Shoe – Only available in White Paint Grade stock color

Base Shoes, like Quarter Rounds, are used to conceal the required expansion space between the wall and the flooring.

Surface Material: Decorative Paper

Core Material: Standard MDF

Length: 94" Long



Wall Base

Base molding conceals the joint between an interior wall and the floor. Also used to protect the walls from scuffs and floor cleaning tools.

Surface Material: Decorative Paper

Core Material: Standard MDF

Length: 94" Long

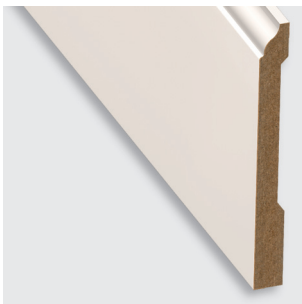
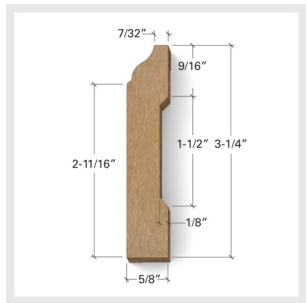

Colonial Base – Only available in White Paint Grade stock color

Extra tall Colonial Base molding conceals the joint between an interior wall and the floor. Also used to protect the walls from scuffs and floor cleaning tools.

Surface Material: Decorative Paper

Core Material: Standard MDF

Length: 94" Long

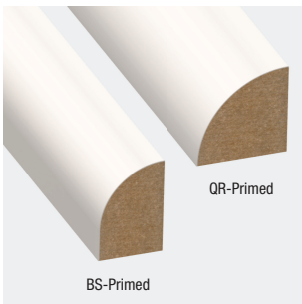
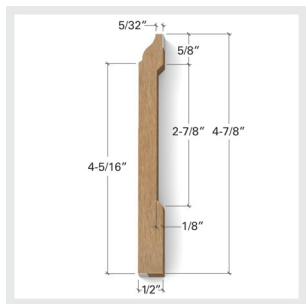

Quarter Round-Primed & Base Shoe-Primed

We offer our popular quarter round and base shoe profiles as primed white and ready-to-paint.

Surface Material: Primed Painted Surface

Core Material: Standard MDF

Length: 96" Long



Primed Qr & BS

Product	SKU Number	Length	Minimums to Order
Quarter Round-Primed	QR-Primed-96	96" Long	Pallet of 1,800
Base Shoe-Primed	BS-Primed-96	96" Long	Pallet of 2,700

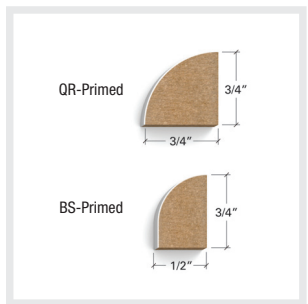

*All references to flooring thickness refer to the total thickness of all components of the floor installation being laid upon the subfloor. This typically is comprised of the flooring plank, e.g. Vinyl or Laminate, the underlayment, either attached or loose lay and any additional vapor barriers.



Order online at versatrim.com or call **1.866.200.8132**

Stair Solutions

STAIR SOLUTIONS:



Round Stair Nose (RSN)

The Round Stair Nose combines style and function to enhance the beauty of a staircase or step. For use on flooring with an overall thickness of up to 3/4" (19 mm)*.

Surface Material: High-Wear Resistant Aluminum Oxide Laminate

Core Material: PVC

Length: 94" Long

Floor Thickness*	Install Type	Accessories Needed
1/16"-5/16" (1-8 mm)	Overlap	None
1/16"-3/4" (1-19 mm)	Overlap on Box Stair Case	Bull Nose Shim
3/32"-5/32" (2-4 mm)	Flush	None
3/16"-9/32" (5-7 mm)	Flush	VT-VE(X)-Shim-5- <i>Sold Separately</i>
5/16"-11/32" (8-10 mm)	Flush	VT-VE(X)-Shim-8- <i>Sold Separately</i>
1/2" (12 mm)	Flush	VT-VE(X)-Shim-12- <i>Sold Separately</i>

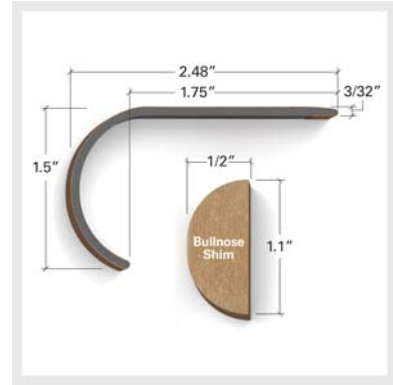

VersaEdge

The VersaEdge Stair Nose combines style and function to enhance the beauty of a staircase or step. For use on flooring with an overall thickness of up to 3/4" (19 mm)*.

Surface Material: High-Wear Resistant Aluminum Oxide Laminate

Core Material: PVC

Length: 94" Long

Floor Thickness*	Install Type	Accessories Needed
1/16"-3/4" (1-19 mm)	Overlap	None
3/32"-5/32" (2-4 mm)	Flush	None
3/16"-9/32" (5-7 mm)	Flush	VT-VE(X)-Shim-5- <i>Sold Separately</i>
5/16"-11/32" (8-10 mm)	Flush	VT-VE(X)-Shim-8- <i>Sold Separately</i>
1/2" (12 mm)	Flush	VT-VE(X)-Shim-12- <i>Sold Separately</i>



VersaEdge Extra Tall (VEX)

The VersaEdge Extra Tall Stair Nose is 1.5" tall to fit staircases or steps that require a longer overhang. For use on flooring with an overall thickness of up to 3/4" (19 mm)*.

Surface Material: High Wear Resistant Aluminum Oxide Laminate

Core Material: Aluminum

Length: 94" Long

Floor Thickness*	Install Type	Accessories Needed
1/16"-3/4" (1-19 mm)	Overlap	None
3/32"-5/32" (2-4 mm)	Flush	None
3/16"-9/32" (5-7 mm)	Flush	VT-VE(X)-Shim-5- <i>Sold Separately</i>
5/16"-11/32" (8-10 mm)	Flush	VT-VE(X)-Shim-8- <i>Sold Separately</i>
1/2" (12 mm)	Flush	VT-VE(X)-Shim-12- <i>Sold Separately</i>



Moisture Proof Stair Nose

The Moisture-Proof Stair Nose combines style and function to enhance the beauty of a staircase or step.

Surface Material: High-Wear Resistant Aluminum Oxide Laminate

Core Material: Exterior Grade Composite Wood Product.

Length: 94" Long

Floor Thickness*	Install Type	Accessories Needed
15/16" (8 mm)	Overlap	None
15/32" (12 mm)	Overlap	Versatrim Shim (VT-Shim)- <i>Sold Separately</i>



*All references to flooring thickness refer to the total thickness of all components of the floor installation being laid upon the subfloor. This typically is comprised of the flooring plank, e.g. Vinyl or Laminate, the underlayment, either attached or loose lay and any additional vapor barriers.

Need a solution for your stairs? We offer several products to help!



ASK YOUR SALES REP FOR A VERSACAP CATALOG TODAY!

VERSATRIM®
The Leading Molding Brand in North America

VERSACAP

ALWAYS FLUSH & ALWAYS A PERFECT MATCH

#1 Source for Stair Solutions!

MATCHING STAIR SOLUTIONS

Caps Are Made With Your Actual Flooring to Perfectly Match!

The VersaCap is used to create matching, flush stair treads & returns that perfectly match your floor to give your staircase an elegant cohesive look.

VersaCap is available in three profile types depending on your flooring and project needs:

- **VersaCap Edge** - The Edge has a low profile height of 1-7/8"
- **VersaCap Square** - The Square a taller profile height of 2-3/8"
- **VersaCap Round** - The Round profile height of 1-3/4"

Order your flooring plank to complete your tread! Available with a cap purchase only and will be cut to the size of the cap.

VersaCaps are made-to-order: Once an order is placed it cannot be canceled and the product cannot be returned.

Lead Time: Approximately 15 business days

1 Piece Minimum per order



VersaCap

AWARD-WINNING PRODUCT!

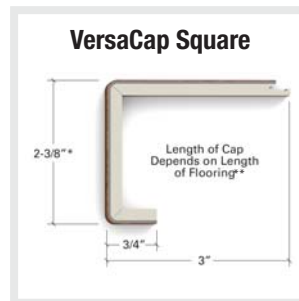

*Since flooring thicknesses vary, to find inside height dim. of your VersaCap, measure the thickness of your floor, multiply it by 2, & subtract it from the outside height.
**VersaCap can be produced in varying length. In standard configuration they can not exceed 46". Please inquire within your sales rep if you have require longer length.

WHITE STAIR RISERS

PRODUCT HIGHLIGHTS:

- Ready to install with a durable TFL white finish
- Lightweight and non-warp particle board core
- Paintable surface*
- Available as a bundle option for our VersaCap

For specs and more detailed information on our risers, see the bottom of page 16.

*Requires a light sanding before painting

Ask About Our New VersaCap Bundle!

Our **VersaCap Bundle** includes the following:

- 1 VersaCap
- 1 Plank
- 1 Riser**

Other bundle options are also available to help complete your stair project:

- 1 VersaCap & 1 Plank
- 1 VersaCap & 1 Riser**

Ask a Sales Representative For Additional Details & Pricing

**Riser only offered in 3/8 x 46 for bundle. Riser quantity must equal VersaCap quantity ordered. No special cut on Risers.



VERSATRIM™ TREADS

Versatrim offers a custom full tread stair solution made from your exact floor planks.

Choose from three profiles—Round, Square, or Edge—for quick installation with our Molding Adhesive. Also available as a pack with our TFL risers

AVAILABLE IN:



Installation with Versatrim Molding Adhesive is required for warranty coverage.

To Purchase: Scan the QR Code or Visit Versatrim.com

See Page 6 for more information or page 26 for pricing

HOW TO ORDER

PROGRAM OPTIONS/
PARTNERSHIPS

PRODUCTS

APPLICATIONS

MARKETING ASSISTANCE/
SUSTAINABILITY

SHIPPING INFORMATION/
LEAD TIMES

PRICING



VersaFlex



VERSAFLEX

by Versatrim®

Flexible Moldings in 8 Shapes! *Stainable & Paintable!**



End Cap



Reducer

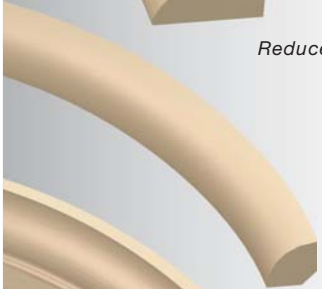

1/2" Base Shoe



4-7/8" Colonial Base**



T-Molding



Corner Molding



3/4" Quarter Round



3-1/4" Wall Base**



*Must use a gel-type stain or latex/oil-based paint.
**Special Order Item. Longer Lead Times May Apply.

VERSAFLEX: FLEXIBLE MOLDINGS

Material: Polyurethane Composite Material
Surface: Stainable and Paintable*
Length: 94" Long



VersaFlex End Cap

End Caps are used to transition from laminate to carpet, masonry (fireplaces), sliding doors and other exterior door jambs.

Available In: **SKU# 120336** – Oak Wood Grain

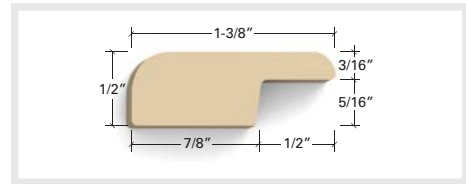

VersaFlex T-Molding

T-Moldings are commonly used in doorways to join two laminate floors in adjoining rooms. Also recommended when making a transition from one floor to another floor that is approximately the same height.

Available In: **SKU# 120336** – Oak Wood Grain

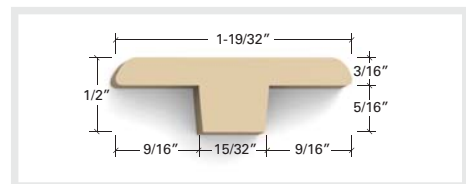

VersaFlex Reducer

Reducers are used to transition between floors of different heights with a minimum height difference of 1/4" (6.35 mm).

Available In: **SKU# 120336** – Oak Wood Grain

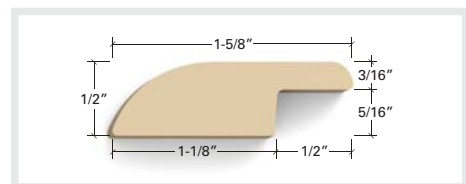

VersaFlex Corner Molding - **NEW! In Stock!**

Corner Moldings are used to for corners and edges.

Available In: **SKU# 120336** – Oak Wood Grain

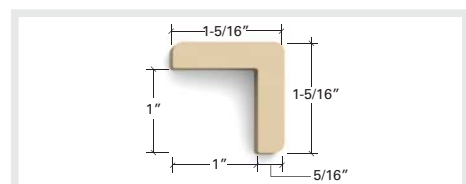

VersaFlex Quarter Round

Quarter Rounds are used to conceal the required expansion space between the wall and the flooring.

Available In: **SKU# 120335** – Paint Grade (No Grain)
SKU# 120336 – Oak Wood Grain

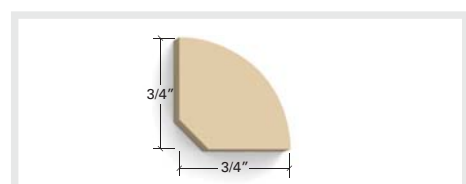

VersaFlex Base Shoe

Base Shoes, like Quarter Rounds, are used to conceal the required expansion space between the wall and the flooring.

Available In: **SKU# 120335** – Paint Grade (No Grain)
SKU# 120336 – Oak Wood Grain

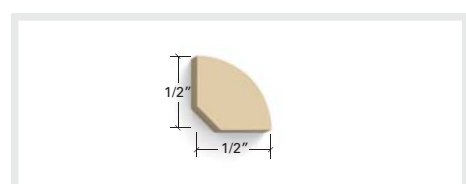

VersaFlex Wall Base *Special Order Item. Longer Lead Times May Apply.*

Base moldings conceal the joint between an interior wall and the floor. Also used to protect the walls from scuffs and floor cleaning tools.

Available In: **SKU# 120335** – Paint Grade (No Grain)
SKU# 120336 – Oak Wood Grain

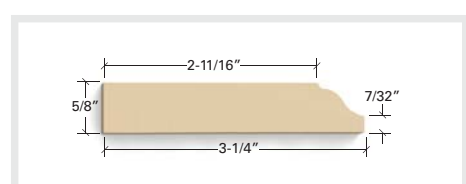

VersaFlex Colonial Base *Special Order Item. Longer Lead Times May Apply.*

Colonial Base molding conceals the joint between an interior wall and the floor. Also used to protect the walls from scuffs and floor cleaning tools.

Available In: **SKU# 120335** – Paint Grade (No Grain)
SKU# 120336 – Oak Wood Grain

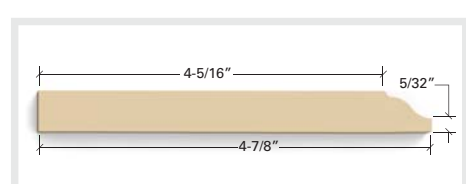

*Must use a gel-type stain or latex/oil-based paint.

HOW TO ORDER	PROGRAM OPTIONS/ PARTNERSHIPS	PRODUCTS	APPLICATIONS	MARKETING ASSISTANCE/ SUSTAINABILITY	SHIPPING INFORMATION/ LEAD TIMES	PRICING
--------------	----------------------------------	----------	--------------	---	-------------------------------------	---------



Accessories



ACCESSORIES for Transition Moldings:



Dowel Tree

To be used with SlimTrim for floors up to 3/4" (19 mm)*. Comes as a tree of 8 dowels. One tree covers one 94" long Slim Trim molding with each dowel spaced approximately 12" apart and 1" from each end.

Material: High Density Polyethylene

Included with SlimTrim-P32

FOR USE WITH:

- SlimTrim



SlimTrack

At Versatrim, we designed our SlimTrack to perfectly fit our SlimTrim and SlimCap solutions, so you can have the same molding on thin floors up to 1/8" (3 mm) in thickness, as you would any other floor. To be used in conjunction with the Versatrack Shim with thicknesses of 1/8" (3 mm) to 1/4" (6.35 mm).

Material: Cold Roll Steel

Length: 94" Long

Included with SlimTrim-P29 and SlimTrim-P54

FOR USE WITH:

- SlimTrim
- SlimCap

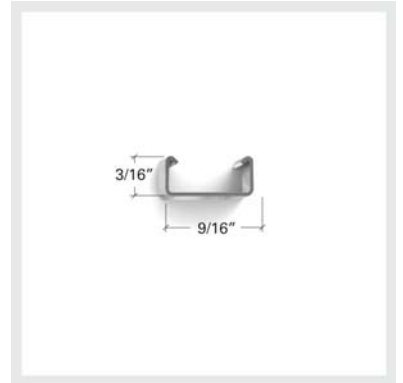

Versatrack (Metal Track)

To be used with T-Molding for floors from 23/64"-15/32" (9-12 mm)** thickness and Reducer & End Cap for floors from 9/32"-15/32" (7-12 mm)** thickness. Can also be used with T-Molding in conjunction with the Versatrack shim for floors from 15/32"-45/64" (12-18 mm)** thickness and with Reducer & End Cap in conjunction with the Versatrack shim for floors from 15/32"-5/8" (12-16 mm)** thickness.

Material: Cold Roll Steel

Length: 94" Long

FOR USE WITH:

- T-Molding
- Reducer
- End Cap

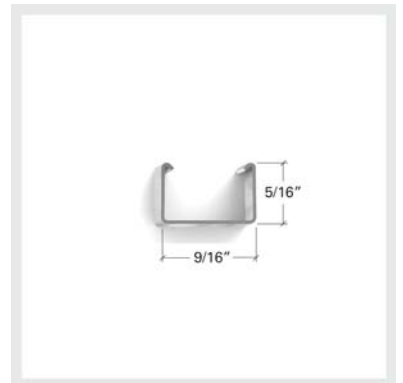

Versatrack Shim

To be used with T-Molding in conjunction with the Versatrack for floors from 15/32"-45/64" (12-18 mm)* thickness and with Reducer & End Cap in conjunction with the Versatrack for floors from 15/32"-5/8" (12-16 mm)* thickness. Our Versatrack Shim was also designed to be used with our SlimTrim for floors up to 9.5 mm and our SlimCap for floors up to 12.7 mm.

Material: Standard HDF

Length: 94" Long

1 Included with SlimTrim-P29 and 2 included with SlimTrim-P54

FOR USE WITH:

- T-Molding
- Reducer
- End Cap
- SlimTrim
- SlimCap

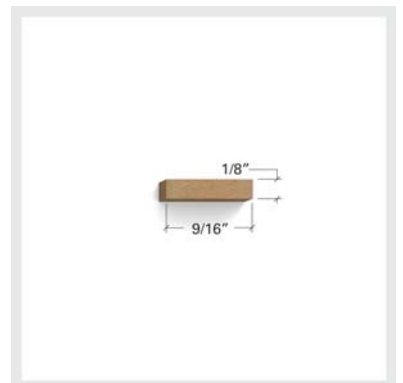

*All references to flooring thickness refer to the total thickness of all components of the floor installation being laid upon the subfloor. This typically is comprised of the flooring plank, e.g. Vinyl or Laminate, the underlayment, either attached or loose lay and any additional vapor barriers.

**For floors thicker than 45/64" (18 mm)* for T-Molding and 5/8" (16 mm)* for Reducer & End Cap, please contact our team of customer service representatives for assistance in choosing the right reducer molding for your project.

ACCESSORIES for Stair Solutions:



Versatrim Shim (VT Shim)

Used to raise the landing Stair Nose when used for 3/8-1/2" (9.5-12.7 mm) Flooring.

Material: MDF/HDF

Length: 94" Long

FOR USE WITH:

- Stair Nose

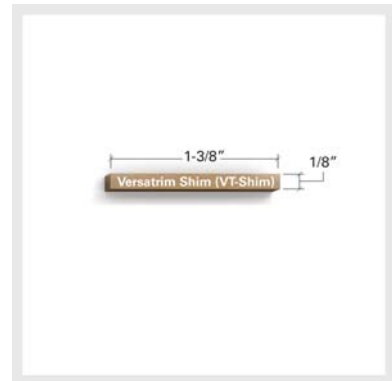

VT-VE(X)-Shims

This Versatrim shim is available for optional use with our Round Stair Nose molding (RSN) and VersaEdge for flush installations. We carry a variety of sizes to fit your needs, including Shim-5 for 5-7 mm* floors, Shim-8 for 8-10 mm floors*, and Shim-12 for 12 mm* floors.

Material: MDF/HDF

Length: 94" Long

FOR USE WITH:

- VersaEdge
- VersaEdge Extra Tall
- Round Stair Nose



Bullnose Shim

Our Bullnose Shim is to be used to install our Round Stair Nose molding (RSN), specifically on box staircases, to create a stabilized, rounded step.

Material: Standard MDF

Length: 94" Long

FOR USE WITH:

- Round Stair Nose



White TFL Stair Riser

Used to enhance stair landings. Our white stair risers come in white surface material. No need to paint it white. It is also paintable if you prefer another color.

Surface Material: High Quality TFL (Thermally Fused Laminate)

Core Material: Standard Particle Board

Thickness: Our risers come in 2 thicknesses: 3/8" and 5/8" thick

Length: Comes in 2 lengths: 46" and 96" long

This product is excluded from our free shipping options.

46" Risers ship in bundles of 4 or individually with a VersaCap order.

96" Risers are sold by the pallet (min of 100 pcs.) and ship LTL only.

See VersaCap Bundle options on page 12.

We do not cut risers; we only sell as stock 46" and 96" lengths.

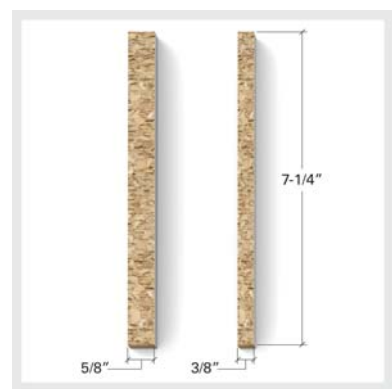

*All references to flooring thickness refer to the total thickness of all components of the floor installation being laid upon the subfloor. This typically is comprised of the flooring plank, e.g. Vinyl or Laminate, the underlayment, either attached or loose lay and any additional vapor barriers.



Product Details



ACCESSORIES for Installation:



BlueZone Perimeter Tape* - **NEW! In Stock!**

BlueZone outperforms traditional caulking methods. BlueZone applied around the perimeter of flooring installations will effectively seal the expansion area, preventing spills from damaging both the flooring and subfloor.

The ease of use encourages proper perimeter sealing, keeping your floor and subfloor safe for the life of the flooring with proven moisture-proofing technology against liquids, including pet urine.

BlueZone has been proven to be more effective than the standard silicone/backer rod process. Offering a lower cost and more consistent, easier application. Choose BlueZone for a reliable, efficient, and long-lasting flooring protection solution.

Material: Constructed from high-grade 6 mil polyethylene and a permanently tacky rubber adhesive

FOR USE WITH:

- All of our floor moldings and trims.

- Easy, clean application
- No special tools needed
- Low-temperature adherence
- Tear resistance
- Prevents moisture intrusion into floor expansion areas
- Low cost
- Bonds well to most surfaces



CalFlor Flooring Installation Kit with VersaBlock* - **NEW! In Stock!**

CalFlor® Installation Kit with VersaBlock® features quality products, designed to make your projects go smoothly.

The kit includes:

- 1 VersaBlock Tapping Block
- 1 Heavy Duty Steel Pull Bar
- 20 Stepped Spacers

FOR USE WITH:

- For Vinyl, Laminate, & Engineered Flooring

- Sturdy tapered steel pull bar to withstand many installs
- Stepped installation spacers are suitable for different expansion specs
- VersaBlock (Also available separately), features 3 different edges to work with multiple styles of flooring



VersaBlock* - **NEW! In Stock!**

VersaBlock is the perfect tool for all skill levels. Unlike regular tapping blocks that only accommodate one or two flooring edge profiles, the VersaBlock can handle thin, medium, and thick floors, ensuring perfect contact every time.

To maximize the utility of the tapping block features include a ruler, pencil holes for tracing wall curvature and creating straight lines, and a knife notch to help cut off flooring edges with ease.

FOR USE WITH:

- For Vinyl, Laminate, & Engineered Flooring

- Multi-use tool
- Easy Use
- Sturdy Material
- For use with wood, laminate and vinyl flooring products
- Buyer-friendly product minimizes the amount of tools needed on both current & future installs



Molding Adhesive by Versatrim*

The only molding adhesive you'll need! This wet-set, early-grab, 12-hour curing formula is low-odor and easy-to-clean, leaving no surface residue or ghosting, even once dried. It provides an excellent bond for moldings. Comes in a 10 oz. cartridge.

28 oz. Cartridge COMING SOON!

FOR USE WITH:

- All moldings, trim & stair solutions

- No Shrink Formula
- High Strength, Waterproof
- Extremely Low VOC
- Covers roughly 15-20 Lin. Ft. depending on application and bead size.
- No Surface Residue
- 12-Hour Cure Time



10-Inch Saw Blade*

Our high quality 10" Saw Blade is ideal for floor moldings and is designed for ultra smooth cross cutting on a table saw or miter saw. Blade work on all Versatrim products, including VersaCaps & VersaEdge Extra Tall (VEX).

FOR USE WITH:

- All moldings, trim & stair solutions

- Carbide Tipped for long life & smooth cuts
- 80 Teeth Alternate Bevel
- Wide range of use, including aluminum
- Blade can be sharpened
- Heat Resistant Non-Stick Coating for cleaner cuts

***Ships Free with Any Molding Order!**

Need installation instructions? Go to www.versatrim.com/technical-specifications.



Order online at versatrim.com or call **1.866.200.8132**

Vents

VERSATRIM INTRODUCING FITTES VENTS - *NEW! In Stock!*

Introducing 8 new in-stock Fittes vents! These stylish and functional vents are the perfect complement to your flooring projects, adding a touch of modern elegance to any space.

Key features of the new vents include:

- Sleek and contemporary design that seamlessly blends with modern interiors
- Durable construction for long-lasting performance and reliability
- Easy installation for convenience and efficiency in your projects

Additional vent sizes available as Special Order Items. Contact your Sales Representative today for more information.



Framed Floor Vent [Lite]

Minimalist-framed vent made of ABS plastic. This DIY-friendly vent can be retrofitted to any surface.

Core Material: ABS Plastic

Available in 2 sizes: **4" x 10"** and **4" x 12"**

Framed Floor Vent [Lite]

4"x10" / Matte Black - LITE4X10BLK

Framed Floor Vent [Lite]

4"x12" / Matte Black - LITE4X12BLK



Dimensions

LITE	4"x10"	4"x12"
A1	11"	12-7/8"
A2	5"	5"
A3	1-7/8"	1-7/8"
A4	1/8"	1/8"
A5	9-3/4"	11-5/8"
A6	3-3/4"	3-3/4"
A7	3/8"	3/8"
B1	8-7/8"	10-5/8"
B2	2-13/16"	2-13/16"
B3	3/4"	3/4"
B4	3/8"	3/8"

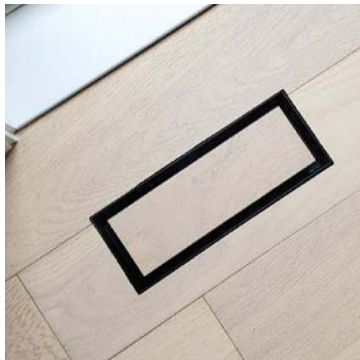
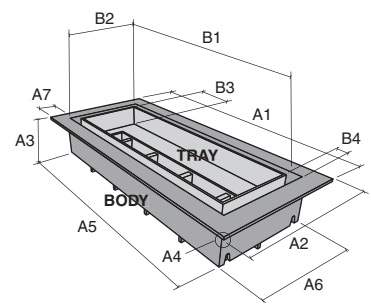

Flush Floor Vent [Lite]

Ultra-minimal, frameless floor vent made in a combination of ABS plastic and solid steel. Once installed, all that is visible is the air channel.

Core Material: Combination of ABS Plastic and Powder-Coated Galvanneal Steel

Available in 2 sizes: **4" x 10"** and **4" x 12"**

Flush Floor Vent [Lite]

4"x10" / Matte Black - FMLIT4X10BLK

Flush Floor Vent [Lite]

4"x12" / Matte Black - FMLIT4X12BLK



Dimensions

	4"x10"	4"x12"
A1	8-7/8"	10-13/16"
A2	2-7/8"	2-7/8"
A3	7/8"	7/8"
B1	9-3/4"	11-3/4"
B2	3-11/16"	3-13/16"
B3	1-7/8"	1-7/8"
C1	11-1/16"	13-1/16"
C2	5-1/16"	5-1/16"
C3	1/32"	1/32"
C4	5/8"	5/8"
D1	9-15/16"	11-7/8"
D2	3-7/8"	3-15/16"
D3	1-7/8"	1-11/16"

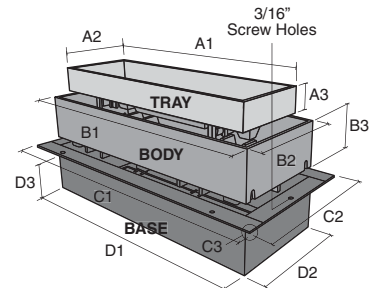

Framed OG Floor Vent [Luxe]

The original "OG" is the go-to minimalist-framed vent. This solid steel vent can be retrofitted to any surface. Easy drop-in install. DIY friendly.

Core Material: Powder-Coated Galvanneal Steel

Available in 2 sizes: **4" x 10"** and **4" x 12"**

Framed OG Floor Vent [Luxe]

4"x10" / Matte Black - AV4X10BLK

Framed OG Floor Vent [Luxe]

4"x12" / Matte Black - AV4X12BLK



Dimensions

OG	4"x10"	4"x12"
A1	11"	13"
A2	5"	5"
A3	1-13/16"	1-13/16"
A4	1/16"	1/16"
A5	9-3/4"	11-3/4"
A6	3-3/4"	3-3/4"
A7	5/8"	5/8"
B1	8-11/16"	10-11/16"
B2	2-3/4"	2-3/4"
B3	7/8"	7/8"
B4	7/16"	7/16"

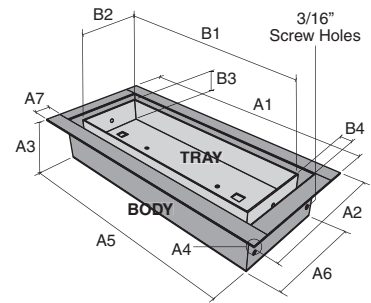

Flush Floor Vent [Luxe]

The ultra-minimal, frameless floor vent. Flush with no rim - only a single rectangular air channel is visible. This model must be mounted prior to the surface.

Core Material: Powder-Coated Galvanneal Steel

Available in 2 sizes: **4" x 10"** and **4" x 12"**

Flush Floor Vent [Luxe]

4"x10" / Matte Black - FLUSH4X10BLK

Flush Floor Vent [Luxe]

4"x12" / Matte Black - FLUSH4X12BLK



Dimensions

	4"x10"	4"x12"
A1	8-11/16"	10-11/16"
A2	2-13/16"	2-13/16"
A3	7/8"	7/8"
B1	9-3/4"	11-3/4"
B2	3-3/4"	3-3/4"
B3	1-13/16"	1-13/16"
C1	11-1/16"	13-1/16"
C2	5-1/16"	5-1/16"
C3	1/32"	1/32"
C4	5/8"	5/8"
D1	9-15/16"	11-7/8"
D2	3-7/8"	3-7/8"
D3	1-5/8"	1-11/16"

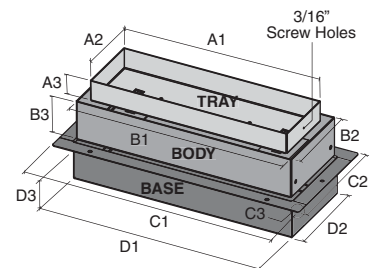

HOW TO ORDER

PROGRAM OPTIONS/
PARTNERSHIPS

PRODUCTS

APPLICATIONS

MARKETING ASSISTANCE/
SUSTAINABILITY

SHIPPING INFORMATION/
LEAD TIMES

PRICING



Technical Details



APPLICATIONS*

This is how the Versatrim molding covers 9/32-45/64" (7-18mm) Flooring. The answer to the problem is a program of moldings designed to work with a metal track.

End Cap, Reducer, and T-Molding

Versatrack Floors 9/32-15/32" (7-12mm)**

Versatrack with Shim Floors 15/32-5/8" (12-16mm)**

Versatrack Floors 23/64-15/32" (9-12mm) Without Track for 5/16" (8mm)****

Versatrack with Shim Floors 15/32-19/32" (12-15mm)**

Versatrack with 2 Shim Floors 19/32-45/64" (15-18mm)**

SlimCap (PVC End Cap)

SlimTrack Floors Up to 3/16" (0-4.5mm)**

SlimTrack & Shim Floors 3/16-3/8" (4.5-9.5mm)**

SlimTrack & 2 Shims Floors 3/8-1/2" (9.5-12.7mm)**

VersaEdge, VersaEdge Extra Tall, and Round Stair Nose (RSN)

VersaEdge and VersaEdge Extra Tall Stair Nose covers floors up to an overall thickness of 3/4" (19mm) and RSN covers floors up to an overall thickness of 12mm.

VersaEdge & VEX

Overlap Install

"Locked-Down" Install

Used where floating of the floor is not required, as with Stair Tread or Glued-Down/Nailed-Down floors. This can be used on floating floors where expansion and contraction will occur on the opposite side of the flooring plane.

"Floating" Install

Used where floating of the floor is required.

Flush Install "Locked-Down" Install

Used where floating of the floor is not required, as with Stair Tread or Glued-Down/Nailed-Down floors. This can be used on floating floors where expansion and contraction will occur on the opposite side of the flooring plane. **Tongue side of plank MUST face the VersaEdge. VersaEdge, Shims, and flooring planks must be glued down to subfloor.**

Floors with an overall thickness of **2-3 mm****

Molding Adhesive (p. 14)
Add a little more adhesive to make the VersaEdge even with floor

Floors with an overall thickness of **4 mm****

Molding Adhesive (p. 14)
Add a little more adhesive to make the VersaEdge even with floor

Floors with an overall thickness of **5-12 mm****

VT-VE(X) Shim
(See Shim Guide below for which Shim to use with your floor)

Molding Adhesive (p. 14)

VT-VE(X)-Shim Guide

- VT-VE(X)-Shim-5 for 5-7 mm** Floors
- VT-VE(X)-Shim-8 for 8-10 mm** Floors
- VT-VE(X)-Shim-12 for 12 mm** Floors

Installation is the same for VersaEdge Extra Tall. VT-VE(X)-SHIMS are sold separately.

Round Stair Nose (RSN)

Overlap Install

"Locked-Down" Install

Used where floating of the floor is not required, as with Stair Tread or Glued-Down/Nailed-Down floors. This can be used on floating floors where expansion and contraction will occur on the opposite side of the flooring plane.

"Floating" Install

Used where floating of the floor is required.

"Lock-Down" on Box Staircase

Flush Install "Locked-Down" Install

Used where floating of the floor is not required, as with Stair Tread or Glued-Down/Nailed-Down floors. This can be used on floating floors where expansion and contraction will occur on the opposite side of the flooring plane. **Tongue side of plank MUST face the VersaEdge. VersaEdge, Shims, and flooring planks must be glued down to subfloor.**

Floors with an overall thickness of **2-3 mm****

Molding Adhesive (p. 14)
Add enough adhesive to make the Stair Nose even with floor

Floors with an overall thickness of **4 mm****

Molding Adhesive (p. 14)

Floors with an overall thickness of **5-12 mm****

Molding Adhesive (p. 14)

VT-VE(X) Shim
(See Shim Guide at the right for which Shim to use with your floor)

VT-VE(X)-Shim Guide

- VT-VE(X)-Shim-5 for 5-7 mm** Floors
- VT-VE(X)-Shim-8 for 8-10 mm** Floors
- VT-VE(X)-Shim-12 for 12 mm** Floors

*The installation instructions shown on pages 19 & 20 are suggestions of how to install our moldings. Versatrim does not assume responsibility for any product failure or liability due to installations that are in violation of the flooring manufacturer's installation guidelines and/or warranties.
 **All references to flooring thickness refer to the total thickness of all components of the floor installation being laid upon the subfloor. This typically is comprised of the flooring plank, e.g. Vinyl or Laminate, the underlayment, either attached or loose lay and any additional vapor barriers.

SlimTrim on LVT Floors

1 Reducer:
Up to 1/4"
(0-6.35* mm)**



2 Transition:
1/16 to 1/8"
(1.6-3mm)** 1/8-1/4"
(3-6.35* mm)**

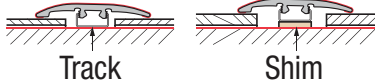

3 End Cap: *Hard Surface to Carpet*
Up to 1/4"
(0-6.35* mm)**

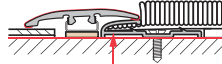

Carpet Tap Down Trim

A Carpet Tap Down Trim **MUST** Be Used When Installing SlimTrim on Carpet.

SlimTrim on WPC Floors

1 SlimTrim-P29
as a **Reducer**
1/4-3/8"
(6.35* -9.5mm)**

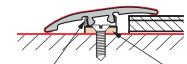

SlimTrack Shim

2 SlimTrim-P54
as a **Transition**
1/4-3/8"
(6.35* -9.5mm)**

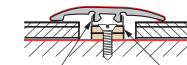

SlimTrack **2** Shims

SlimTrim on Laminate Floors

1 Reducer:
Up to 3/4"
(0-19mm)**

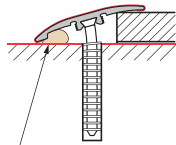

Must Be Glued to Non-Floating Surface

2 Transition:
Up to 3/4"
(0-19mm)**

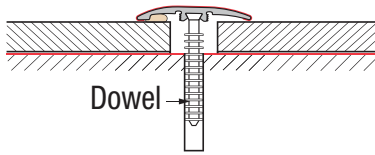

3 End Cap: *Hard Surface to Carpet*
Up to 3/4"
(0-19mm)**

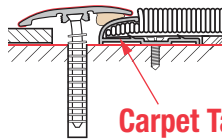

Carpet Tap Down Trim

Moisture Proof Stair Nose, Quarter Round, Base Show, Wall Base and Colonial Base Installation

Our Moisture Proof Stair Nose works with 8mm and 12 mm Floors**. Our bases are easy to install and can be used in any combination of the two.

Moisture Proof Stair Nose

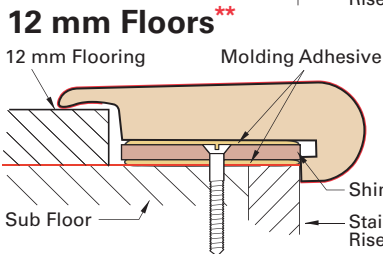
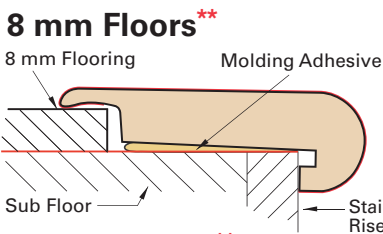

Quarter Round, Base Shoe, & Bases

Wall Base with Quarter Round or Base Shoe

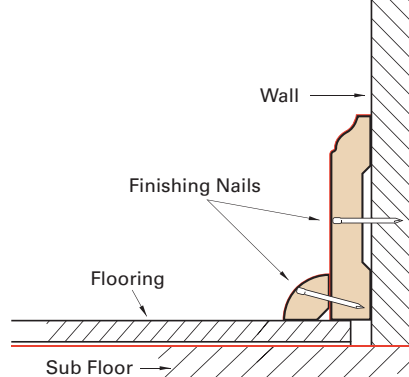

Colonial Base with Quarter Round or Base Shoe

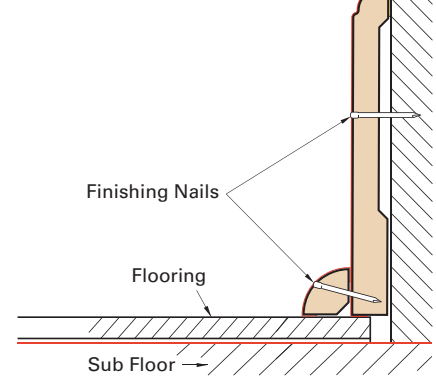

Need Help Installing? Go to:
www.versatrim.com/technical-specifications

This site is provided as a convenience to our customers for simple Versatrim step-by-step installation instructions as PDFs and easy to follow videos.



*For floors thicker than 1/4" (6.35mm), use dowel installation.
**All references to flooring thickness refer to the total thickness of all components of the floor installation being laid upon the subfloor. This typically is comprised of the flooring plank, e.g. Vinyl or Laminate, the underlayment, either attached or loose lay and any additional vapor barriers.



Samples



MARKETING ASSISTANCE

Display Board

Our 12" x 42" display board features our moldings profiles: SlimTrim, SlimCap, VersaEdge, Versa Edge Extra Tall, Round Stair Nose, Moisture Proof Stair Nose, End Cap, Reducer, T-Molding, Quarter Round, Base Shoe, Wall Base & Colonial Base.



Standard Color Book

Our 3.75" x 8" color book fits conveniently in a pocket, drawer, or glove compartment and is handy any time you need to match our moldings to your floor. The book represents all standard stock colors.



Standard Molding Profile Chain

The Versatrim Sample Chain represents most of our molding profiles and accessories: Slim Track, VersaTrack Shim, Slim Cap, Slim Trim, VersaEdge, VersaEdge Extra Tall, Round Stair Nose, Quarter Round, End Cap, Reducer, T-Molding, Versatrack, Wall Base.



VersaFlex Profile Chain

The VersaFlex Profile Chain represents 6 out of our 8 flexible molding profiles: Corner Molding, Reducer, T-Molding, End Cap, Quarter Round, and Base Shoe. The Wall Base and Colonial Base are special order items that require longer lead times and are not included on the sample chain.



VersaCap 6 Inch Sample Piece

Our 6" long VersaCap sample pieces are easy to handle and are available in Edge, Square, and Round. On the bottom of each sample is a label with product specs and dimensions. Our VersaCaps match your floor perfectly, because they are made from the actual flooring.



VersaCap Handheld Display

Our 7" (w) x 7" (d) x 2.5" (h) Handheld VersaCap Display demonstrates how our VersaCap Square and Round will look installed.



Versatrim Tread Sample

Our 10" long Versatrim Tread sample pieces show off our new full tread stair solutions! They come in Round, Square and Edge. The branded tape on the top side of the tread is removed after actual full-size tread installation.



Free samples are for flooring businesses only.

SUSTAINABILITY



Sustainability

Embracing Green Practices for a Sustainable Future

At Versatrim, we are committed to making a positive impact on the environment and promoting sustainable development in the construction industry. We are excited to share with you our innovative solutions that not only enhance the aesthetics and functionality of your projects but also contribute to a greener and more sustainable future.



Eco-Friendly Materials

Our products are crafted using high-quality, environmentally friendly materials that are sourced responsibly. We prioritize the use of recycled and renewable materials, reducing our carbon footprint and minimizing waste.



Waste Reduction

We are dedicated to minimizing waste throughout our manufacturing process. By utilizing advanced production techniques and optimizing material usage, we significantly reduce waste generation. Our commitment to recycling cardboard and aluminum and repurposing further ensures that materials are diverted from landfills.



Longevity and Durability

Versatrim products are built to last, reducing the need for frequent replacements and minimizing waste generation over time. Our durable materials and expert craftsmanship ensure that your projects maintain their quality and appearance for years to come.

Join us in embracing sustainable development and making a positive impact on the environment. Together, we can create a greener future for generations to come.



FLOORING TRIM & MOLDINGS MADE IN THE USA

Versatrim proudly manufactures all flooring trims and moldings in the USA.

Since 1998 our company has been proudly making quality products in our manufacturing facility in Henderson, North Carolina.

Our entire team at Versatrim is dedicated to providing you with the very highest quality products by great service. We welcome the opportunity to serve you.

Thank you for considering Versatrim and supporting made in the U.S.A products.



Made in USA





Shipping



QUANTITIES

Standard Stock Moldings	Quantities Per Tube		Quantities Per Box (Pallets Only)	
	Pieces Per 3" Tube	Pieces Per 6" Tube	Pieces Per Box	Boxes Per Pallet
SlimTrim	8	34	5	220
SlimCap	10	35	5	220
T-Molding	10	45	10	140
Reducer	10	40	10	140
End Cap	12	50	10	140
RSN – Round PVC Stair Nose	4	30	5	220
VersaEdge – Standard	8	40	5	220
VersaEdge Extra Tall	6	35	5	220
Stair Nose	4	19	5	140
Wall Base	NONE	10	5	110
Colonial Base	NONE	7	4	133
Quarter Round	13	50	10	220
Base Shoe	30	110	20	220

VersaFlex Flexible Moldings	Pieces Per 3" Tube	Pieces Per 6" Tube	Pieces Per Box	Boxes Per Pallet
VersaFlex End Cap	12	50	1	150
VersaFlex T-Molding	10	45	1	150
VersaFlex Reducer	10	40	1	150
VersaFlex Quarter Round	13	50	1	150
VersaFlex Base Shoe	30	110	1	150
VersaFlex Wall Base	NONE	10	1	64
VersaFlex Colonial Base	NONE	7	1	40
VersaFlex Corner Molding	6	20	1	150

Accessories	Pieces Per 3" Tube	Pieces Per 6" Tube	Pieces Per Box	Boxes Per Pallet
Versatrim Shim (VT-Shim)	30	120	25	220
VT-VE(X)-Shim-5	30	120	25	220
VT-VE(X)-Shim-8	12	55	10	220
VT-VE(X)-Shim-12	8	31	8	220
Versatrack Shim <small>Use with Versatrack and SlimTrack</small>	70	280	55	220
Versatrack	50	120	40	110
SlimTrack	80	140	50	110
Dowels - Tree of 8	NA	NA	1000	24
Bullnose Shim	12	50	10	220

Quantities may vary when packaging option selected.

No Minimums to Order

SHIPPING POLICY

Effective March 1, 2024

All shipping costs will be based on the actual order weight and shown on the order confirmation.

Please contact our customer service department for shipping charges for Hawaii, Alaska and any location outside the United States of America.

Seasonal surcharges may apply.

Transit Time

Transit times reflect **standard business days** which does not include Saturday or Sunday. **Saturday delivery may be available upon request at an additional cost.**

Lead times are for FedEx Ground Shipments. LTL Shipments with trucking companies have a similar transit time, for exact transit times please contact your sales associate.

Transit may take an additional day or two at times.

A \$5.00 Handling Fee Will Be Added to All Orders

Effective May 1, 2023

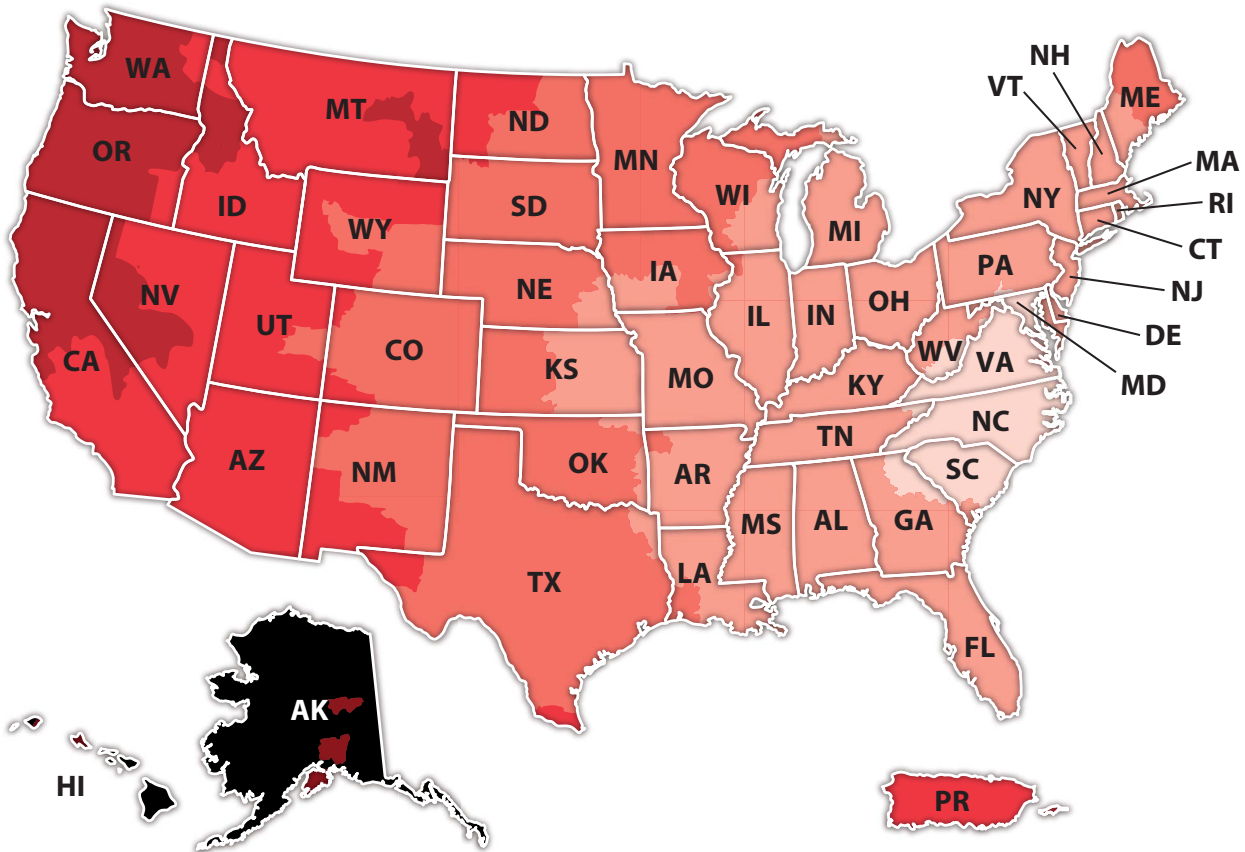





























7 Days
 6 Days
 5 Days
 4 Days
 3 Days
 2 Days
 1 Day

HOW TO ORDER
PROGRAM OPTIONS/ PARTNERSHIPS
PRODUCTS
APPLICATIONS
MARKETING ASSISTANCE/ SUSTAINABILITY
SHIPPING INFORMATION/ LEAD TIMES
PRICING

Moldings

Manufacturer Price List

(FOB Henderson, NC)

		Standard Stock Colors	Coordinating Moldings/ Custom Colors	Custom Colors/ Coordinating Moldings
Effective 1/01/24	Quantities	1 Piece	1 to 29 Pieces	30 Pieces and Up***
	Lead Time*	Ships Next Business Day on Most Items**	Ships within 7 Business Days	Ships within 15 Business Days
	Returns	Item is Returnable	Custom Product: Non-Returnable	Custom Product: Non-Returnable
SLT P29 P31 P32 P33 P54	 SlimTrim-P29 For Vinyl/LVT Floors Up to 6.35 mm (1/4")	US - \$11.85 Hardware Included	US - \$17.04 Hardware Included	US - \$12.67 Hardware Included
	 SlimTrim-P31 For Vinyl/WPC/LVT/Laminate Up to 19 mm (3/4")	US - \$13.42 Hardware Included	US - \$18.61 Hardware Included	US - \$14.24 Hardware Included
	 SlimTrim-P32 For Laminate Floors Up to 19 mm (3/4")	US - \$11.12 Hardware Included	US - \$16.31 Hardware Included	US - \$11.94 Hardware Included
	 SlimTrim-P33 For Vinyl/LVT Floors Under 3 mm (1/8")	US - \$10.05	US - \$15.24	US - \$10.87
	 SlimTrim-P54 For WPC/LVT Floors 6.35 to 9.5 mm (1/4-3/8")	US - \$12.38 Hardware Included	US - \$17.57 Hardware Included	US - \$13.20 Hardware Included
	 Additional Dowel Tree Use with SlimTrim on Floors up to 19mm (3/4"). Contains 8 Dowels	US - \$1.01	US - \$1.01	US - \$1.01
 Additional SlimTrack Use in conjunction with Versatrack Shim on SlimTrim for floors up to 9.5 mm (3/8") and SlimCap for floors up to 12.7mm (1/2").	US - \$2.24	US - \$2.24	US - \$2.24	
 Additional Versatrack Shim Use with SlimTrack for SlimTrim on 3-9.5mm floors, and SlimCap on 5-12.7mm floors	US - \$0.60	US - \$0.60	US - \$0.60	
RSN SCAP P29 P54	 SlimCap-P29 For Up to 9.5 mm (3/8") Floors	US - \$17.04** Hardware Included	US - \$17.04 Hardware Included	US - \$12.67 Hardware Included
	 SlimCap-P54 For 10 to 12.7 mm (3/8" to 1/2") Floors	US - \$17.57** Hardware Included	US - \$17.57 Hardware Included	US - \$13.20 Hardware Included
RSN	 RSN Round PVC Stair Nose	US - \$23.32**	US - \$23.32	US - \$17.87
	 Bullnose Shim Use with RSN for installation on Box Staircases	US - \$2.35	US - \$2.35	US - \$2.35
VEX VE	 VersaEdge Stair Nose 1" Height	US - \$11.33	US - \$18.88	US - \$11.95
	 VersaEdge Extra Tall Stair Nose 1.5" Height	US - \$23.32**	US - \$23.32	US - \$17.87
	 VT-VE(X)-Shim-5 For VE, RSN, or VEX for Optional Flush Install on 5-7 mm floors	US - \$1.52	US - \$1.52	US - \$1.52
	 VT-VE(X)-Shim-8 For VE, RSN, or VEX for Optional Flush Install on 8 mm floors			
 VT-VE(X)-Shim-12 For VE, RSN, or VEX for Optional Flush Install on 12 mm floors				
EC TM RD	 End Cap Hardware not included	US - \$8.70 Standard	US - \$16.80** Moisture Proof	US - \$16.80 Moisture Proof Only
	 T-Molding Hardware not included	US - \$8.70 Standard	US - \$16.80** Moisture Proof	US - \$16.80 Moisture Proof Only
	 Reducer Hardware not included	US - \$8.70 Standard	US - \$16.80** Moisture Proof	US - \$16.80 Moisture Proof Only
	 Versatrack - OPTIONAL For Reducer, T-Molding, & End Cap on 6-9.5 mm floors	US - \$2.23	US - \$2.23	US - \$2.23
	 Versatrack Shim - OPTIONAL Use with Versatrack for Reducer, T-Molding, & End Cap on 9.5-12.7 mm floors	US - \$0.60	US - \$0.60	US - \$0.60
	MRSN	 Moisture Proof Stair Nose	US - \$22.00** Moisture Proof	US - \$22.00 Moisture Proof Only
 Versatrim Shim For Moisture Proof Stair Nose on 12 mm floors - OPTIONAL		US - \$1.52	US - \$1.52	US - \$1.52
WB CB	 Wall Base 3.25" High	US - \$7.20	NA	US - \$7.83
	 Colonial Base 4.875" High	US - \$10.45 Available in White Paint Grade Only	NA	NA
QR BS	 Quarter Round Available in Standard or Moisture Proof	US - \$3.11 Standard	US - \$6.54** Moisture Proof	US - \$5.38 Standard
	 Base Shoe	US - \$3.10 Available in White Paint Grade Only	NA	US - \$4.45 Moisture Proof

All Moldings are 94" Long

*Visit versatrim.com for leadtime information.

**Stock Color VersaEdge Extra Tall, SlimCap, Round Stair Nose, and Moisture Proof Moldings (Reducer, End Cap, T-Molding, Stair Nose & Quarter Round) are made to order and are non-returnable.

***Customer is expected to accept & pay for a 10% over or under run on Custom Color moldings.

Terms: Our Credit Application form is available at versatrim.com/how-to-order.

Pricing Subject to Change / Cancellation Fee Could Apply

Additional Products Manufacturer Price List

(FOB Henderson, NC)

Effective 9/24/24		Quantities	SKU# 120335 Paint Grade (No Grain)	SKU# 120336 Oak Wood Grain
		Lead Time	1 Piece 1 to 2 Business Days on Most Items*	1 Piece 1 to 2 Business Days on Most Items*
VELEX EC TM RD QR BS WB CB CM		VersaFlex End Cap	NA	US - \$25.08
		VersaFlex T-Molding	NA	US - \$35.54
		VersaFlex Reducer	NA	US - \$26.31
		VersaFlex Quarter Round	US - \$24.34	US - \$24.34
		VersaFlex Base Shoe	US - \$19.17	US - \$19.17
		VersaFlex Wall Base*	US - \$66.77*	US - \$66.77*
		VersaFlex Colonial Base*	US - \$79.08*	US - \$79.08*
		VersaFlex Corner Molding	NA	US - \$20.79

	QTY or Size	Price	Shipping Cost
	1 Ten oz. Tube	US - \$9.99 per Tube	Ships Free w/Molding Order or \$8.50 for adhesive only orders Ships Free w/Molding Order or \$8.50 for adhesive only orders
	1 Case/12 Tubes	US - \$109.00 per Case	
	1 Blade	US - \$49.99 per Blade	Ships Free w/Molding Order or \$8.50 for blade only orders
	1 Roll	US - \$14.98 per Roll	Ships Free w/Molding Order or \$8.50 for tape only orders FOB Henderson
	1 Box/12 Rolls	US - \$162.00 per Box	
	1 Case/144 Rolls	US - \$1,725.00 per Case	FOB Henderson
	1 VersaBlock	US - \$7.00 per Block	Ships Free w/Molding Order or \$8.50 for tape only orders FOB Henderson FOB Henderson
	1 Box/24 Blocks	US - \$151.00 per Box	
	1 Case/72 Blocks	US - \$405.00 per Case	
	1 Kit	US - \$13.50 per Kit	Ships Free w/Molding Order or \$8.50 for tape only orders FOB Henderson
	1 Box/10 Kits	US - \$122.00 per Box	
	3/8 Thick/46" Long	US - \$3.75 per pc. Bundles of 4****	FOB Henderson
	3/8 Thick/96" Long	US - \$7.05 per pc. Sold by the Pallet (Min 100 pcs)	FOB Henderson
	5/8 Thick/46" Long	US - \$3.75 per pc. Bundles of 4****	FOB Henderson
	5/8 Thick/96" Long	US - \$7.05 per pc. Sold by the Pallet (Min 100 pcs)	FOB Henderson
	96" Long	US - \$2.48 per pc. Sold by the Pallet (Min 1,800 pcs)	FOB Henderson
		96" Long	US - \$2.21 per pc. Sold by the Pallet (Min 2,700 pcs)
	4"x10" / Matte Black - LITE4X10BLK	4"x10"	US - \$23.00 per pc. Ships Free w/Molding Order or \$15 for vent only orders
	4"x12" / Matte Black - LITE4X12BLK	4"x12"	US - \$26.00 per pc. Ships Free w/Molding Order or \$15 for vent only orders
	4"x10" / Matte Black - FMLIT4X10BLK	4"x10"	US - \$49.00 per pc. Ships Free w/Molding Order or \$15 for vent only orders
	4"x12" / Matte Black - FMLIT4X12BLK	4"x12"	US - \$53.00 per pc. Ships Free w/Molding Order or \$15 for vent only orders
	4"x10" / Matte Black - AV4X10BLK	4"x10"	US - \$70.00 per pc. Ships Free w/Molding Order or \$15 for vent only orders
	4"x12" / Matte Black - AV4X12BLK	4"x12"	US - \$80.00 per pc. Ships Free w/Molding Order or \$15 for vent only orders
	4"x10" / Matte Black - FLUSH4X10BLK	4"x10"	US - \$80.00 per pc. Ships Free w/Molding Order or \$15 for vent only orders
	4"x12" / Matte Black - FLUSH4X12BLK	4"x12"	US - \$90.00 per pc. Ships Free w/Molding Order or \$15 for vent only orders

*VersaFlex Wall Base and VersaFlex Colonial Base are Special Order Items and are subject to longer lead times. Lead times apply to orders up to 5 pieces. Larger orders require longer lead times.
**Ships free with any molding order. \$8.50 shipping & handling fee will apply for adhesive, tape, installation kit, or VersaBlock only orders. For lower 48 Continental United States Only.

****Ships in bundles of 4 or individually with a VersaCap order.

*****Ships free with any molding order. \$15 shipping & handling fee will apply for vent only orders. For lower 48 Continental United States Only.

Terms: Our Credit Application form is available at versatrim.com/how-to-order.

Pricing Subject to Change / Cancellation Fee Could Apply

HOW TO ORDER
PROGRAM OPTIONS/
PARTNERSHIPS
PRODUCTS
APPLICATIONS
MARKETING ASSISTANCE/
SUSTAINABILITY
SHIPPING INFORMATION/
LEAD TIMES
PRICING

EXPERIENCE the Versatrim Difference With Our **ONLINE STORE!**

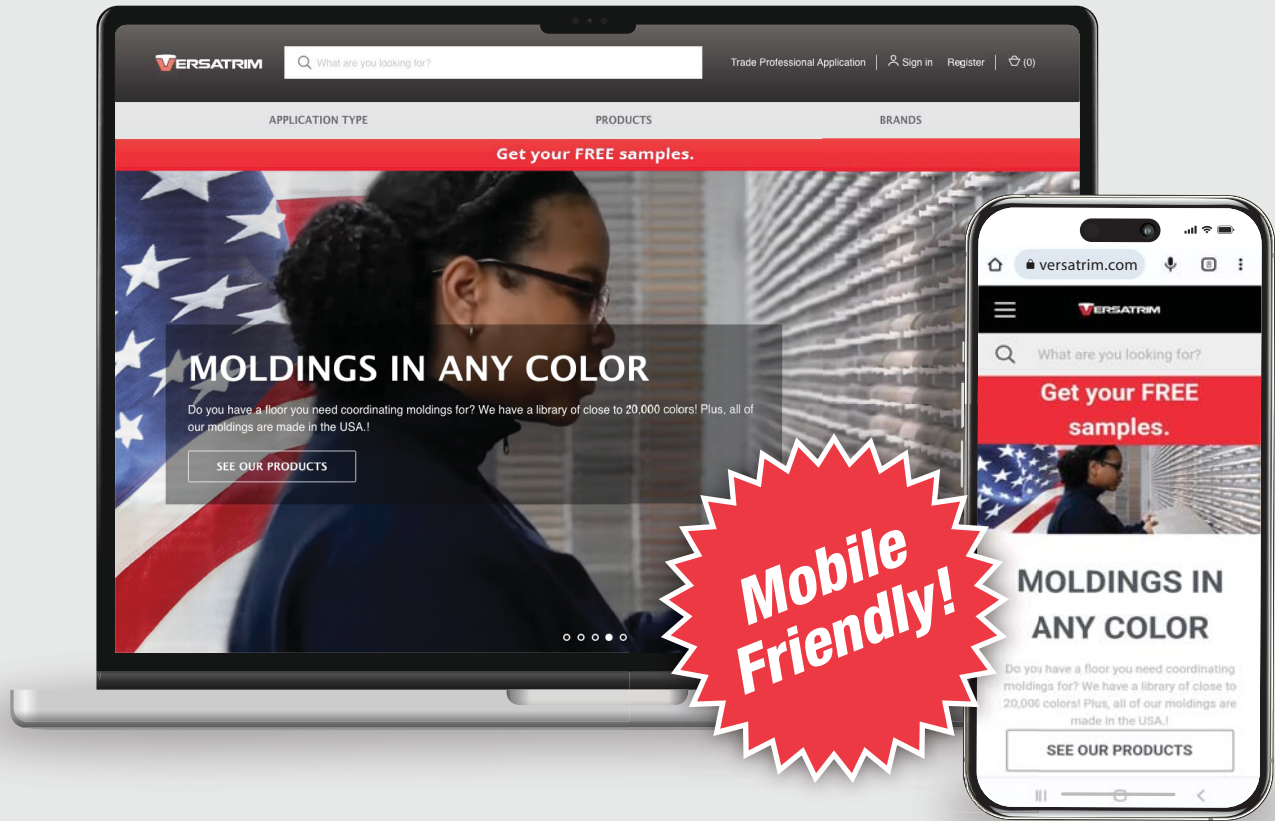

Quick Ship Items & No Minimums!

Versatrim.com

SHOP NOW!



1.866.200.8132

Versatrim LLC, 101 Eastern Minerals Road, Henderson, NC 27537 USA • versatrim.com • sales@versatrim.com

Versatrim, an award-winning leader in the flooring industry located just outside Raleigh, NC, distinguishes itself through its comprehensive line of custom-coordinated floor moldings and trims tailored for laminate and vinyl flooring. Versatrim's innovative approach to molding solutions, coupled with its expert coordination with the latest color trends in the vinyl, LVT, WPC, SPC, and laminate flooring sectors, has propelled the company to the forefront as a premier manufacturer of floor moldings and accessories.

Follow Us:



1200-01/25-A

© 2025 Versatrim, LLC. All rights reserved.

Manufacturer